

*YOU MUST
SUBSCRIBE TO YOUR
NETWORK PROVIDER'S CALLER
DISPLAY SERVICE BEFORE THIS
FEATURE WILL WORK



User Guide

BT FREESTYLE 2100



This equipment is not designed for making telephone calls when the power fails. Alternative arrangements should be made for access to emergency services.

This product is intended for connection to analogue public switched telephone networks and private switchboards in the United Kingdom.

Quick guide to the menu structure

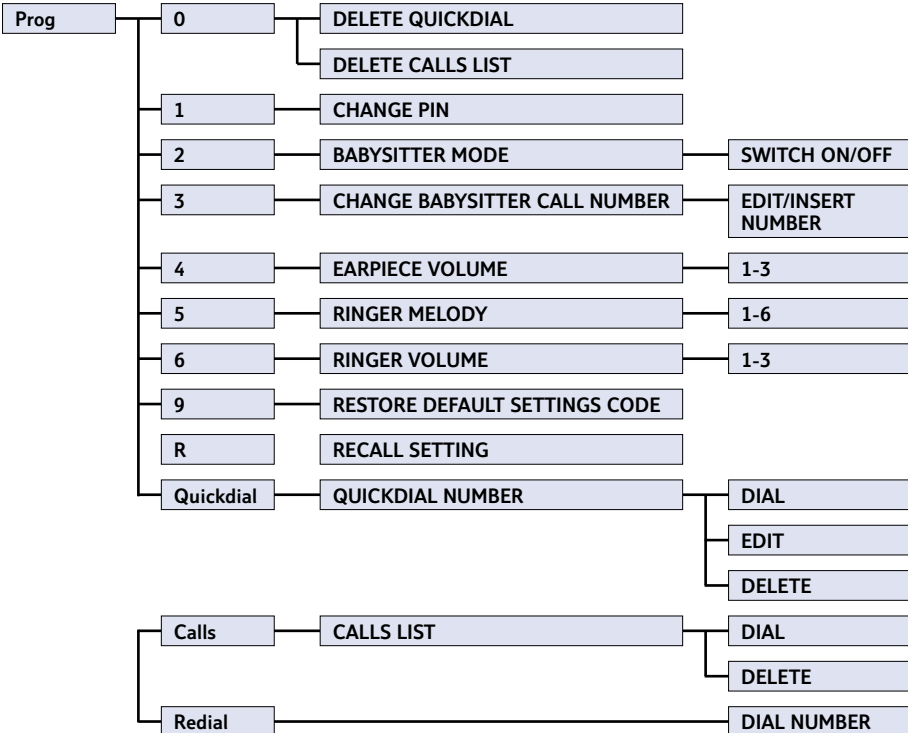























Customer Helpline

If you experience any difficulties please call the Helpline on 0870 240 3962 or email bt.freestyle.helpdesk@vtecheurope.com

Quick guide

For the handset settings

Function	Key combination
Answer a call	 *
Make a call	  or  
End a call	
Redial a number	 Press until the number you want is displayed 
Store a number	 -  -  again to scroll to Quickdial location Enter telephone number to be stored - 
Dial a Quickdial	 - 0 to 9 ^{W/K/L} or  again to scroll - 
Adjust earpiece volume	 - 4 ^{GH} - 1 to 3 ^{DEF} to set level - 
Secrecy on/off	During a call press 
Adjust ringier melody	 - 5 ^{JKL} - 1 to 6 ^{MNO} to set melody - 
Keypad lock/unlock	Press and hold 
Handset ringer off/on	Press and hold 

Important

**If the handset is sitting in a base when a call comes in, you can pick it up and answer it automatically without pressing the TALK button. A call can be ended by pressing the TALK button or just placing it back in the base.*

In this guide

Please note that there is a detailed Index at the back of this guide, see page 26.

At a glance	1	Caller Display	17
		<i>Using Caller Display</i>	17
Quick guide to the menu structure	3	<i>The Calls list</i>	17
Quick guide for the handset settings	4	Handset settings	19
		<i>Babysitter mode</i>	21
Introduction	6	Help	23
<i>Unpacking your Freestyle 2100</i>	7	General information	24
<i>For your records</i>	8	<i>Guarantee</i>	24
Safety information	9	<i>Technical information</i>	25
		<i>Switchboard compatibility</i>	25
Setting up	10	<i>Switchboard external line access code</i>	25
Using your Freestyle 2100	13	Index	26
<i>Making and receiving calls</i>	13	Wall mounting template	28
<i>Secrecy</i>	14		
<i>Internal calls</i>	15		
<i>Transferring calls</i>	15		
<i>10 Last number redial</i>	15		
<i>Quickdial directory</i>	15		

Please note

In this user guide, we've included helpful tips and useful notes. They are shown in a white box like this.

Introduction

Your Freestyle 2100 has been designed for ease of use and made to the high standards set by BT

Please read the instructions carefully before use and retain this user guide for future reference.

DECT

By purchasing the Freestyle 2100 you now own a product which combines the advantages of cordless operation with the performance of a high quality corded telephone. It complies with the Digitally Enhanced Cordless Telecommunications (DECT) standard and offers unparalleled quality and features.

GAP (Generic Access Profile)

The Freestyle 2100 is a non GAP product. This means that no other handsets can be registered to the Freestyle 2100 base station and that Freestyle 2100 handsets cannot be registered to any other base station.

- If you have purchased the Freestyle 2100 you will have a single handset product.
- If you have purchased the Freestyle 2100 Twin you will have the use of two handsets which will be pre-registered to the base station.

This user guide applies to both single and twin handset systems. The internal call functions described in this guide apply only to Freestyle 2100 base stations with more than one handset connected.

Unpacking your Freestyle 2100

If anything is missing, please contact your place of purchase immediately.

- Freestyle 2100 handset.



- Freestyle 2100 base station.



- Plug mounted, 13 amp mains adaptor.



- Telephone line cord.



- 2 x AAA rechargeable handset batteries (packed with battery cover).



- Battery compartment cover.



- Wall mounting screws and wall plugs



Unpacking your Freestyle 2100 Twin

- 2 x Freestyle 2100 handsets.



- 1 x Freestyle 2100 base station.



- 1 x Freestyle 2100 charger.



- 2 x Plug mounted, 13 amp mains adaptors.



- Telephone line cord.



- 4 x AAA rechargeable handset batteries (packed with battery cover).

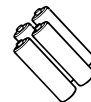

- 2 x Battery compartment covers.



- Wall mounting screws and wall plugs



Unpacking your Freestyle 2100 Twin ACR

- 2 x Freestyle 2100 handsets.



- 1 x Freestyle 2100 base station.



- 1 x Freestyle alarm clock radio charger.



- 1 x Freestyle 2100 base station plug mounted 13 amp mains adaptor. (Item code 009294)



- 1 x Freestyle alarm clock radio charger plug mounted 13 amp mains adaptor. (Item code 009865)



- Telephone line cord.



- 4 x AAA rechargeable handset batteries (packed with battery cover).

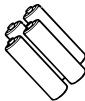

- 2 x Battery compartment covers.



- Wall mounting screws and wall plugs



For your records

Date of purchase:

Place of purchase:

Serial number (on the underside of telephone base):

Purchase price:

For guarantee purposes, proof of purchase is required, so please keep your receipt.

Customer Helpline

If you experience any difficulties please call the Helpline on 0870 240 3962 or email bt.freestyle.helpdesk@vtecheurope.com

Safety information

General

Only use the power supply included with the product. Using an unauthorised power supply will invalidate your guarantee and may damage the telephone. The item code for the Freestyle 2100 base station mains power supply is 009294. The item code for the Freestyle alarm clock radio charger mains power supply is 009865.

Only use the approved rechargeable batteries supplied. Spare rechargeable batteries are available from the Freestyle Helpline **0870 240 3962**.

If the keypad is locked, it is NOT possible to make emergency calls to **999** and **112**.

*If the handset has been set to Babysitter mode it can only be used to dial the one number that has been set. You will not be able to make calls to **999** or **112** unless you choose to store one of these numbers.*

Do not open the handset (except to replace the handset batteries) or charger. This could expose you to high voltages or other risks. Contact the Helpline for all repairs.

Radio signals transmitted between the handset and base may cause interference to hearing aids.

It is recommended that advice from a qualified expert be sought before using this product in the vicinity of emergency/intensive care medical equipment.

It is recommended that if you have a pacemaker fitted you check with a medical expert before using this product.

Never dispose of batteries in a fire. There is a serious risk of explosion and/or the release of highly toxic chemicals.

Cleaning

Simply clean the handset and base with a damp (not wet) cloth, or an antistatic wipe. Never use household polish as this will damage the product. Never use a dry cloth as this may cause a static shock.

Environmental

Do not expose to direct sunlight.

The product may heat up when the batteries are being recharged or during prolonged periods of use. This is normal. However, we recommend to avoid damage you do not place the product on antique/ veneered wood.

Do not stand your product on carpets or other surfaces which generate fibres, or place it in locations preventing free flow of air over its surfaces.

Do not submerge any part of your product in water and do not use it in damp or humid conditions, such as in bathrooms.

Do not expose your product to fire, explosive or other hazardous conditions.

There is a slight chance that your phone could be damaged by an electrical storm. We recommend that you unplug the power and telephone line cord for the duration of the storm.

Setting up

Follow these steps to set up your Freestyle 2100 ready for use

Plan the location of your Freestyle 2100

The following points should be considered:

- Situate your product close enough to the power socket so that the cable will reach safely without stretching. Ensure that you plan the location so that the mains power is easily accessible in case you need to disconnect the power.
- Make sure it is at least 1 metre away from other electrical products to avoid interference.

Please note

The Freestyle 2100 has a range of up to 300 metres outdoors and up to 50 metres indoors. The range will be reduced when there is no clear line of sight between the base and handset. Thick stone walls can severely affect the range.

1 Connect the base station

Plug the power supply cable into the power socket on the underside of your base.

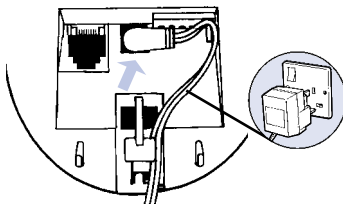

2 Plug the power supply unit into the wall socket

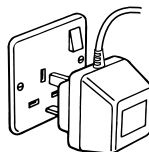

3 Install the rechargeable batteries in the handset

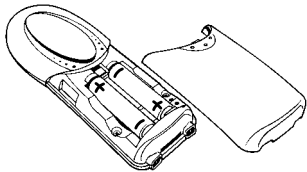

The handset uses two rechargeable Nickel Metal Hydride (Ni-MH) AAA batteries which are supplied. Take care to insert the batteries as shown and then fit the battery cover (this can be found in the packaging with the batteries).

4 Charge the handset for at least 16 hours

Before you use your Freestyle 2100 for the first time, it is important to have the batteries fully charged. The batteries need to charge continuously for at least 16 hours to reach full charge.

Place the handset on the base, the battery icon will initially show empty. After a short time period the battery icon will show 100%. This means that the battery is charging and does not mean that the handset is fully charged.

Once the battery has been fully charged (after the initial 16 hours) and the handset is removed from the base the battery icon will show 50%, this shows that the battery is charging correctly.

Battery levels

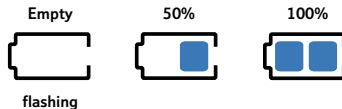

Battery low warning

If the handset battery symbol is empty and flashing, you will need to recharge your handset before you can use it.

Battery performance

Under no circumstances should non-rechargeable batteries be used. Only use the approved batteries, type: rechargeable Nickel Metal Hydride (NiMH); Size AAA; Capacity 600 mAh. Using unapproved batteries will invalidate your guarantee and may damage the telephone.

To keep your batteries in the best condition, leave the handset off the charger for a few hours at a time (after the initial 16 hour charge).

Please note, however, that new Nickel Metal Hydride (Ni-MH) batteries do not reach their full capacity until they have been in normal use for several days.

Battery performance (cont)

Fully discharging the batteries at least once a week will help them to last as long as possible. However, the charge capacity of rechargeable batteries will reduce with time as they wear out, so reducing the talk/standby time of the handset. Eventually they will need to be replaced.

Please note

Under ideal conditions, the handset battery should give about 10 hours talktime or 100 hours standby on a single charge. Optimum time for talk and standby are only achieved when the handset batteries are new and fully charged.

5 Connect the telephone line cord to the base and plug into the wall socket

Ensure that each end of the line cord is fitted into the correct socket.

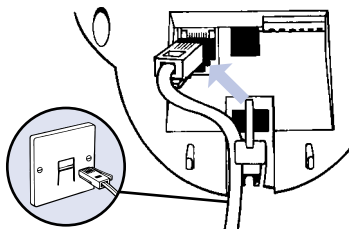

Using your Freestyle 2100 telephone

Making and receiving calls

To make a call



Press the **TALK** button. The display will show the  icon and you will hear the dial tone.



Enter the telephone number. It is dialled automatically.

To end a call



Press the **TALK** button.

Or

Place the handset back in the base.

Preparatory dialling

Preparatory dialling allows you to enter the number before pressing the **TALK** button. This enables you to correct any mistakes before you actually make the call.



First enter the telephone number to be dialled.

The number is shown on the display.



If you make a mistake you can delete a digit by pressing the **CLEAR** button.



Press the **TALK** button to dial the number.

To receive a call

When the telephone rings the display shows the  icon.

If you have subscribed to a Caller Display Service your caller's number will be shown. If the caller has withheld their number, the display will show _____.



Press the **TALK** button or pick the handset up from the base to answer the call.

To page your handset(s)

You can page your handset(s) from the base station to alert a handset user that they are wanted or to locate a missing handset.



Press the **PAGE** button on the base station. The handset(s) will begin to ring.



Press the **PAGE** button again to stop ringing.



You can also stop the ringing by pressing the **TALK** button on the handset. If you have purchased the Freestyle 2100 Twin, pressing the **TALK** button will stop the ringing at that handset only.

To adjust the earpiece volume

There are 3 volume levels to select from.



Press the **PROG** button.



Press the **4** button.



Press **1-3** to set the volume you want. (1 is the quietest and 3 the loudest volume setting.)

A beep sounds at each level you press.



Press **PROG** to confirm.

Please note

When programming your Freestyle 2100, the unit will give a double, two tone beep after the successful sequence and a single, long beep in the case of an error.

Secrecy

When you are on a call you can talk to someone in the same room without your caller hearing.

To switch secrecy on and off

During a call:



Press the **CLEAR** button. The display will show the  icon. Your caller cannot hear you.



Press the **CLEAR** button again to return to your caller.

Internal calls

If you have purchased the Freestyle 2100 Twin, you will be able to make internal calls between handsets.

To make an internal call

 R

Press *and hold* the **R** button until the  icon and *Int* are displayed.

The other handset will ring.



To end the internal call, press the **TALK** button.

10 Last number redial

Your handset automatically saves the last 10 numbers called for redialling.

To redial the last number called



Press the **REDIAL** button to display the last number dialled. Further presses of the **REDIAL** button will display previous numbers dialled (up to 10).



Press the **TALK** button to dial the number displayed.

Transferring calls

If you are using the Freestyle 2100 Twin, you can transfer an external call to the other handset.

To transfer a call

 R

During an external call:

Press *and hold* the **R** button.

The external caller will be put on hold and the other handset will ring. The display will show the  icon and *Int*.



When the other handset answers, press the **TALK** button on the handset to complete the call transfer.

Quickdial directory

You can store up to 10 of your most frequently dialled numbers in each of your Freestyle 2100 handsets. Numbers can be up to 18 digits long.

To store a number in the quickdial directory

 Prog

Press the **PROG** button.



Press the **QUICKDIAL** button. The display shows the first entry (quickdial location 0).



Press **QUICKDIAL** again to scroll through the entries, 0-9. These are the locations under which each quickdial number will be stored.



Enter the number you want to store.

Clr.

If you make a mistake, press the **CLEAR** button to delete incorrect digits.

Press the **PROG** button to confirm.

If there are more than 9 digits in the number, \equiv is displayed e.g.

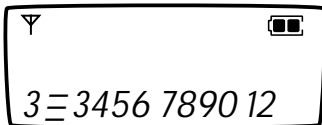

Please note

To enter a pause in a stored number, please see page 25.

To dial/view a stored quickdial number



Press the **QUICKDIAL** button to access the quickdial directory.



Press the **QUICKDIAL** button *repeatedly* to scroll through the quickdial list.

Or



Enter the quickdial location **0-9** to display the number you want.



Press the **TALK** button to dial the displayed number.

Or

Clr.

Press the **CLEAR** button to return to standby.

To change/delete a stored quickdial number



Press the **PROG** button.



Press the **QUICKDIAL** button. The display shows the first entry (quickdial location 0).



Press the **QUICKDIAL** button again to scroll through the entries, **0-9**.



Press the **CLEAR** button to delete individual digits or press *and hold* to delete the whole number.



Enter the new number if required.



Press the **PROG** button to confirm.

To delete all quickdial entries



Press the **PROG** button.



Press the **0** button.



Press the **QUICKDIAL** button.



Press the **PROG** button. All numbers stored in the quickdial memory are deleted.

Please note

If you have purchased a Freestyle 2100 Twin, entries are only deleted on the handset at which you are programming.

Caller Display

IMPORTANT

To use Caller Display you must first subscribe to your network provider's Caller Display feature. A quarterly fee is payable.

For more information on BT Calling Features, call BT free on 0800 800 150.

Using Caller Display

If you subscribe to a Caller Display feature, you can see your caller's number (provided it is not withheld) on your handset display before you answer the call.

If the caller has withheld their number, the display will show _ _ _ _ _.

The Calls List

When a call is not answered (ie. a missed call) your caller's telephone number will be stored in the Calls list. The Calls list holds up to 20 missed calls. An  icon will appear on the display.

When the Calls list is full, the oldest call will be replaced by a new call, the most recent call will always be at the top of the list. If a caller rings again their number will move to the top of the list.

Ring Back calls will display the number you dialled to request the Ring Back service.

To view/dial a number in the Calls list



Press the **CALLS** button. The newest unanswered call is displayed.



Press the **CALLS** button again to scroll through the Calls list.



When the number you want is displayed, press the **TALK** button to dial it.

To delete a number from the Calls list



Press the **CALLS** button. The newest unanswered call is displayed.



Press the **CALLS** button again to scroll through the Calls list to the number you want to delete.



Press *and hold* the **Clr.** button. The number is deleted.



Press the **Clr.** button again to return to standby.

To delete all numbers in the Calls list



Press the **PROG** button.



Press the **0** button.



Press the **CALLS** button



Press the **PROG** button. All numbers stored in the Call list are deleted.

Please note

If you have purchased a Freestyle 2100 Twin, then the Calls list will be deleted on both handsets.

Handset settings

To adjust the handset ringer melody

There are 6 different ringer melodies to choose from.



Press the **PROG** button.



Press the **5** button. The current melody selection is heard.



Press a button **1-6** to select the preferred melody.



Press the **PROG** button to confirm your selection.

To adjust the handset ringer volume



Press the **PROG** button.



Press the **6** button. Ringing at the current volume setting is heard.



Press a button **1-3** to set the preferred volume.



Press the **PROG** button to confirm your selection.

To switch the handset ringer off/on



Press *and hold* the ***** button. The ringer is switched off and the display shows .



Press *and hold* the ***** button again. The ringer is switched back on.

To set the keypad lock

You can lock the handset keypad to prevent accidental button presses.



Press *and hold* the **#** button. The display shows . The keypad buttons are now locked.



Press *and hold* the **#** button again to unlock the keypad.

Please note

You can still answer incoming calls by pressing the **TALK** button when the keypad is locked.

To adjust the Recall setting

The default recall setting (option 2) is set at 100ms which is used by the Public Telephone Network as well as most PBX's. Normally you will not need to change this setting but some PBX's may require a longer recall in which case option 1 (280ms) should be selected.

There are 2 settings to choose from.



Press the **PROG** button.



Press the **R** button.



Press **1-2** for the setting you want.



Press the **PROG** button to confirm.

To restore the default settings

This will return your phone to its original factory settings.



Press the **PROG** button.



Press the **9** button.



Enter the system PIN number (factory setting *0000*).



Press the **PROG** button. The default handset settings are restored.

To change the system PIN number

The system PIN number is factory set to 0000 and is used to access and program certain functions. If you wish you can change this PIN to a four digit number of your choice.



Press the **PROG** button.



Press the **1** button, display shows - - - -.



Enter the existing PIN (0000 if it has not yet been changed since purchase), display shows *0000*.



Press the **PROG** button, display shows - - - -.



Enter your new PIN, display shows 0000.



Press the **PROG** button, display shows - - - -.



Enter your new PIN again, display shows 0000.



Press the **PROG** button, the unit beeps and the display returns to idle.

Your PIN is now changed.

Handset factory settings	
PIN number	0000
Earpiece volume	2
Handset ringer volume	3
Handset melody	1
Keypad lock	Off
Babysitter mode	Off
Redial memory	Empty
Quickdial memory	Empty
Calls list	Empty
Recall	100 ms

Babysitter mode

You can set your Freestyle 2100 handset to dial only a single phone number that you have stored in its memory. This prevents unauthorised calls being made except to the number you specify, this number could be your mobile phone number or another number where you can be reached. This feature could be useful if you are leaving your children with a babysitter and want to leave a contact number, in case of emergencies.

Please note

Babysitting settings will only apply to the handset you programme, therefore if you have purchased a Twin then you may want to programme both handsets.

When babysitter mode is set, you can still receive incoming calls from any number.

IMPORTANT

The Freestyle 2100 handset cannot be used to make emergency 999 or 112 calls when in Babysitter mode unless you choose to store one of these numbers.

To set/change a Babysitter number



Press the **PROG** button.



Press the **3** button.



Enter the system PIN number (factory setting 0000).



Press the **PROG** button.



Enter the number you want to set.

Or



Press *and hold* the **CLEAR** button to delete the number already in the memory, then enter the new number you want to set.



Press the **PROG** button to confirm.

To switch Babysitter mode on

Prog

Press the **PROG** button.

2

Press the **2** button.



Enter the system PIN number (factory setting 0000).

Prog

Press the **PROG** button.

If you switch Babysitter mode on, the number you have set is displayed.

Prog

Press the **PROG** button.

The telephone number you have set remains on the idle display.

While in this mode, your Freestyle 2100 handset can only call the telephone number you have stored.

To dial the Babysitter number



Press the **TALK** button to dial the babysitter number.

Please note

*Pressing any button, other than **PROG** will automatically dial the babysitter number.*

Customer Helpline

*If you experience any difficulties please call the Helpline on **0870 240 3962** or email bt.freestyle.helpdesk@vtecheurope.com*

To switch Babysitter mode off

Prog

Press the **PROG** button.

2

Press the **2** button.



Enter the system PIN number (factory setting 0000).

Prog

Press the **PROG** button.

The number you have set will disappear from the display.

Prog

Press the **PROG** button.

The display will return to standby.

Help

Replacing the handset batteries

After a time, you may find that the handset battery is running out of charge more quickly. This is a standard sign of wear and the batteries will need replacing.

Slide the battery compartment cover off as shown. Take out the old batteries and replace with new ones. New batteries should be rechargeable: Nickel Metal Hydride (NiMH), size AAA, capacity 600mAh.

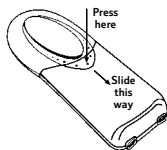

Spare rechargeable batteries are available from the Freestyle 2100 Helpline 0870 240 3962.

Do not immerse batteries in water or throw them into a fire, or dispose of them with ordinary domestic refuse.

BT accepts no responsibility for damage caused to your Freestyle 2100 by using any other types of batteries.

No display appears

The batteries may be flat, dead or incorrectly inserted. Recharge or replace the batteries.

No dial tone

Is the telephone cord of the base plugged into the phone socket.

Check that the base station is connected to the mains power and switched on.

You cannot link up with the base station

Is the aerial icon shown in the top left hand corner of the display. If not:-

1. Check that the mains power cable is connected to the base unit and that the mains switch is on.
2. Check that the handset is within the range of the base station.

Handset does not ring

The ringer volume may be switched off.

Check that the base station is plugged into the phone socket and mains power and switched on.

Buzzing noise on my radio, TV, computer or hearing aid

Sometimes your Freestyle 2100 can interfere with other electrical equipment if it is placed too close.

It is recommended that you place your Freestyle 2100 handset at least one metre away from such appliances to avoid any risk of interference.

Customer Helpline

If you experience any difficulties please call the Helpline on 0870 240 3962 or email bt.freestyle.helpdesk@vtecheurope.com

General information

Guarantee

Your Freestyle 2100 handset is guaranteed for a period of 12 months from the date of purchase.

Subject to the terms listed below, the guarantee will provide for the repair of, or at BT's or its agent's discretion the option to replace the Freestyle 2100, or any component thereof, (other than batteries), which is identified as faulty or below standard, or as a result of inferior workmanship of materials. Products over 28 days old from the date of purchase may be replaced with a refurbished or repaired product.

The conditions of this guarantee are:

- The guarantee shall only apply to defects that occur within the 12 month guarantee period.
- Proof of purchase is required.
- The equipment is returned to BT or its agent as instructed.
- This guarantee does not cover any faults or defects caused by accidents, misuse, fair wear and tear, neglect, tampering with the equipment, or any attempt at adjustment or repair other than through approved agents.
- This guarantee does not affect your statutory rights.

Within the 12 month guarantee period:

If you experience difficulty using the product, prior to returning your product, please contact the BT Freestyle Helpline for assistance on **0870 240 3962** or email:-
bt.helpdesk@vtecheurope.com

Outside of the 12 month guarantee period:

If your product needs repair after the guarantee period has ended, the repair must meet the approval requirements for connection to the telephone network. We recommend that you call the Helpline on **0870 240 3962** and ask for details of our recommended repair agents.

Conditions of Use:

For the conditions of use for BT's products and services, please refer to BT.com.

Technical information

How many telephones can you have?

All items of telephone equipment have a Ringer Equivalence Number (REN), which is used to calculate the number of items which may be connected to any one telephone line. Your Freestyle 2100 has a REN of 1. A total REN of 4 is allowed, if the total REN of 4 is exceeded, the telephones may not ring.

With different telephone types there is no guarantee of ringing, even when the REN is less than 4.

Only use approved power supply, item code 009294.

Only use rechargeable Nickel Metal Hydride (NiMH), size AAA, capacity 600mAh batteries.

Switchboard compatibility

This product is intended for use within the UK for connection to the public telephone network and compatible switchboards, which support tone dialling and timed break recall. If in doubt please consult your switchboard maintainer.

Switchboard external line access code

If you have connected your Freestyle 2100 to a switchboard and the switchboard requires you to wait for a dial tone after dialling the access code needed to make an external call, you will need to enter a pause.

To enter a pause in a stored number

When storing a number, you can insert a pause in the number when the cursor is at the appropriate point, by pressing and holding the  button until a *P* appears in the display.

Index

At a glance			
handset	1	Cleaning	9
base	2	DECT	6
display	2	Default settings	20
Babysitter mode	21	Delete	
dial number	22	calls list number	17
off	22	calls list – all numbers	18
on	22	quickdial number	16
set/change number	21	Display icons	2
Base station		Earpiece volume	14
connection	10	End a call	13
Batteries		Guarantee	24
charging	11	Handset	
install	11	earpiece volume	14
levels	11	internal call	15
low warning	11	keypad lock	19
performance	11	ringer melody	19
Caller Display	17	ringer on/off	19
Calls list	17	ringer volume	19
delete	17	settings – Quick guide	4
delete all	18	transfer external call	15
dial	17	Help	23
view	17	Helpline	23
Calls		Internal call	15
end	13	Keypad lock on/off	19
internal	15	Location of product	10
make	13		
preparatory dialling	13		
receive	13		
redial	15		
secrecy	14		
transfer	15		

M				
Make a call	13	T	Technical information	25
Melody – handset	19		Telephone line connection	12
Menu structure	3		Transfer a call	15
O		U	Unpacking	
On/off			Freestyle 2100	7
babysitter mode	22		Freestyle 2100 Twin	7
keypad lock	19		Freestyle 2100 Twin ACR	8
secrecy	14	V	Volume	
P			earpiece	14
Page a handset	14		handset ringer	19
Pause	25	W	Wall mounting template	28
PIN	20			
Power socket	10			
Power cable	10			
Q				
Quick guide to menu structure	3			
Quick guide for the handset settings	4			
Quickdial directory	15			
change a number	16			
delete a number	16			
delete all numbers	16			
dial a number	16			
store a number	15			
view a number	16			
R				
Recall setting	20			
Receive a call	13			
Redial	15			
REN (Ringer Equivalence Number)	25			
Ringer – handset volume	19			
S				
Safety information	9			
Secrecy	14			
Setting up	10			
Store a number	15			
Switchboard				
access code	25			
compatibility	25			

Wall mounting template

The Freestyle 2100 base station can be free standing or wall mounted.

Cut out this page and place the template on the wall.

The location of the screws is indicated by the centres of the crossed lines.



RTTE

This product is intended for use within the UK for connection to the public telephone network and compatible switchboards.

This equipment complies with the essential requirements for the Radio Equipment and Telecommunications Terminal Equipment Directive 1999/5/EC.

Declaration of Conformance.

Hereby, VTech, declares that this Freestyle 2100 is in compliance with the essential requirements and other relevant provisions of Directive 1999/5/EC.

The Declaration of Conformance for the Freestyle 2100 is published on the web site <http://www.vtecheurope.com>

Visit us at www.bt.com



Offices worldwide

The telecommunications services described in this publication are subject to availability and may be modified from time to time. Services and equipment are provided subject to British Telecommunications plc's respective standard conditions of contract. Nothing in this publication forms any part of any contract.

Touchtone[™] is a registered trade mark of British Telecommunications plc in the UK.

© British Telecommunications plc 2003.
Registered Office: 81 Newgate Street, London EC1A 7AJ.
Registered in England No. 1800000.
Designed by: The Art & Design Partnership Limited.
Freestyle 2100, Issue 3 (7/03) 2
Printed in China.

